

Technical Data
Caractéristiques techniques

LTM 1100/2

Mobile Crane
Grue automotrice

Telescopic boom
Flèche télescopique

171 ft

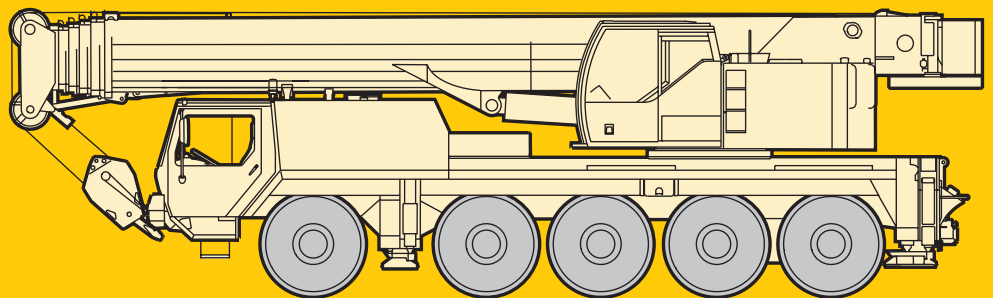

LIEBHERR

Lifting capacities on telescopic boom. Forces de levage à la flèche télescopique.

LTM 1100/2



38 ft – 171 ft



360°

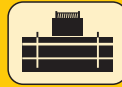

77200 lbs

85%

ft	38 ft		50 ft	62 ft	74 ft	87 ft	99 ft	111 ft	123 ft	135 ft	148 ft	160 ft	171 ft	ft
	* over rear / en arrière													
10	219	198												10
12	189	187	165	156										12
14	166	166	157	150	143	124								14
16	151	151	143	137	132	121	102							16
18	140	139	133	128	123	115	98.5							18
20	130	127	124	119	114	112	94.5	79	67.5					20
22	119	116	116	111	107	108	91.5	76.5	65.5	54.1				22
24	110	106	107	104	100	103	88.5	74	63.5	53.4				24
26	101	96.5	98	97	94.5	97	85.5	71	61.5	52	45.7			26
28	92.5	89	90.5	89.5	88	89.5	83	69	59.5	50.6	44.6	35.1		28
30			83.5	82.5	84	82.5	80.5	66.5	57.6	49.2	43.4	34.9		30
32			77.5	76.5	79	78	77	64	55.7	47.8	42.3	34.2	27.7	32
34			72.5	71.5	74	73.5	72.5	62	54	46.4	41.3	33.6	27.4	34
36			67.5	66.5	69.5	69	68	59.8	52.4	45.2	40.4	33	26.9	36
38			63	63.5	64.5	64	63	57.6	50.7	44	39.4	32.5	26.3	38
40				60.5	60.5	59.9	58.9	55.3	49.1	42.8	38.5	31.9	25.8	40
45				51.9	51.9	51.5	50.5	49.1	45.2	40	36.5	30.7	24.7	45
50				45.2	45.2	44.7	43.7	43.3	40.9	37.1	34.4	29.6	23.7	50
55					39.5	39.1	38.1	38.5	36.4	34.4	32.2	28.3	22.8	55
60					34.9	34.4	33.9	34.3	33.1	31.7	30	26.8	21.9	60
65						31.1	30.5	31.2	30.4	29.4	28.5	25.3	20.9	65
70							27.3	28.2	27.2	26.1	25.8	23.9	20	70
75							24.7	25.4	24.4	23.7	23.7	23.1	22.6	75
80								23	22.6	22.3	21.4	21	21.1	80
85								20.8	20.5	20.1	19.9	19.7	19.1	85
90								19.1	19.2	18.3	18.3	18.1	17.3	90
95									17.7	16.8	16.7	16.5	15.3	95
100										15.9	15.3	14.9	13.5	100
105										14.7	13.6	13.2	12.4	105
110										13.5	12.7	12.3	11.4	110
115											11.8	11.4	10.5	115
120											11	10.6	9.7	120
125												9.8	9	125
130												9.1	8.3	130
135												8.5	7.7	135
140													7.2	140
145													6.6	145
150													6.2	150
155														155
I	0	0/ 0/ 0	46/ 0/ 0	92/46/ 0	46/46/ 0	46/ 0	92/46/46	92/46/46	92/46/ 0	92/46	92	100	I	
II	0	46/ 0/ 0	46/46/ 0	46/46/ 0	92/46/46	46/46	46/92/46	92/92/46	92/92/92	92/92	92	100	II	
III	0	0/46/ 0	0/46/ 0	0/46/46	46/46/46	46/46	46/46/46	46/92/46	92/92/92	92/92	92	100	III	
IV	0	0/ 0/46	0/ 0/46	0/ 0/46	0/46/46	46/46	46/46/46	46/46/92	46/92/92	92/92	92	100	IV	
V	0	0/ 0/ 0	0/ 0/46	0/ 0/46	0/ 0/46	46/92	46/46/92	46/46/92	46/46/92	46/92	92	100	V	

* over rear / en arrière

TAB 130269/130271

Remarks referring to load charts.

- The tabulated lifting capacities do not exceed 85% of the tipping load.
- The crane's structural steelwork is in accordance with DIN 15018, part 3. Design and construction of the crane comply with DIN 15018, part 2, and with F.E.M. regulations.
- The 85% overturning limit values take into account wind force 5 = wind speed 20 mph.
- Lifting capacities are given in kips.
- The weight of the hook blocks and hooks must be deducted from the lifting capacities.
- Working radii are measured from the slewing centreline.
- The lifting capacities given for the telescopic boom only apply if the folding jib is taken off.
- Lifting capacities are subject to modifications.
- Lifting capacities above 198 kips only with special equipment.

Remarques relatives aux tableaux des charges.

- Les forces de levage indiquées ne dépassent pas 85% de la charge de basculement.
- La norme DIN 15018, 3ème partie est appliquée pour les charpentes. La construction de la grue est réalisée conformément à la norme DIN 15018, 2ème partie, et aux règles de la F. E. M.
- A 85% de la charge de basculement, il a été tenu compte d'un vent de force 5 = vitesse de vent 20 mph.
- Les forces de levage sont données en kips.
- Les poids des moufles et crochets doit être soustrait des charges indiquées.
- Les portées sont calculées à partir de l'axe de rotation.
- Les forces indiquées pour la flèche télescopique s'entendent fléchette dépliée déposée.
- Les forces de levage sont modifiables sans préavis.
- Forces de levage plus de 198 kips seulement avec équipement supplémentaire.

Lifting capacities are given in kips (1,000 lbs).

Lifting capacities on telescopic boom. Forces de levage à la flèche télescopique.

LTM 1100/2



38 ft – 171 ft



360°

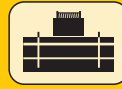

57300 lbs

85%

ft	38 ft		50 ft	62 ft	74 ft	87 ft	99 ft	111 ft	123 ft	135 ft	148 ft	160 ft	171 ft	ft
	* over rear / en arrière													
8	240													8
9	232													9
10	219	198												10
12	189	185	165	156										12
14	166	166	163	156	143	124								14
16	151	150	150	148	132	121	102							16
18	138	135	136	134	123	115	98.5							18
20	126	122	122	122	114	112	94.5	79	67.5					20
22	114	110	111	110	107	105	91.5	76.5	65.5	54.1				22
24	104	99.5	101	100	98.5	96.5	88	74	63.5	53.4				24
26	94.5	90.5	92	91	92	89.5	84	71	61.5	52	45.7			26
28	87	83	84.5	83.5	85.5	82	77.5	69	59.5	50.6	44.6	35.1		28
30			77	76	78.5	75	71	66	57.6	49.2	43.4	34.9		30
32			71	72	72.5	69.5	65.5	62	55.7	47.8	42.3	34.2	27.7	32
34			66	67.5	67.5	64.5	61	58.4	53.4	46.4	41.3	33.6	27.4	34
36			61.5	63	63	60.5	57.2	54.8	50.7	45.2	40.4	33	26.9	36
38			57.1	58.4	58.3	56.1	53.2	51.3	48	44	39.4	32.5	26.3	38
40				54.2	54.2	52.3	49.9	48.6	45.5	42.6	38.5	31.9	25.8	40
45				46.2	46.1	45.1	43.1	42.5	40.1	38.2	36.5	30.7	24.7	45
50				39.9	39.8	39.2	38.9	37.3	35.2	34.1	33.1	29.6	23.7	50
55					34.7	34.2	34.8	32.9	31	31	29.6	28.2	22.8	55
60					30.5	30.1	30.8	29.2	28.3	27.5	27.1	26.3	21.9	60
65					27.1	26.7	27.3	26.8	25.9	25.3	24.9	23.5	20.9	65
70						23.8	24.4	24.1	23.5	23.1	22.5	21.1	20	70
75						21.3	21.9	22.2	21.1	20.9	20.4	19	18.6	75
80							19.8	20	19.6	19.2	18.4	17.2	16.9	80
85							18.6	18.1	17.9	17.3	16.7	15.5	15.3	85
90							17.1	16.4	16.2	15.6	14.7	13.7	13.6	90
95								14.8	14.6	14	13.2	12.3	12.2	95
100									13.2	12.6	12.1	11.1	11	100
105									12.2	11.6	11	10.1	9.9	105
110									11.4	10.6	10.1	9.1	9	110
115										9.8	9.2	8.3	8.2	115
120										9	8.4	7.5	7.4	120
125											7.7	6.8	6.7	125
130											7.1	6.2	6.1	130
135											6.6	5.6	5.5	135
140												5.1	5	140
145												4.6	4.5	145
150												4.1	4	150
155													3.6	155
%	I	0	0/ 0/ 0	46/ 0/ 0	92/46/ 0	46/46/ 0	46/ 0/ 0	92/46/46	92/46/46	92/46/ 0	92/46	92	100	I
	II	0	46/ 0/ 0	46/46/ 0	46/46/ 0	92/46/46	46/46/ 0	46/92/46	92/92/46	92/92/92	92/92	92	100	II
	III	0	0/46/ 0	0/46/ 0	0/46/46	46/46/46	46/46/46	46/46/46	46/92/46	92/92/92	92/92	92	100	III
	IV	0	0/ 0/46	0/ 0/46	0/ 0/46	0/46/46	46/46/92	46/46/46	46/46/92	46/92/92	92/92	92	100	IV
	V	0	0/ 0/ 0	0/ 0/46	0/ 0/46	0/ 0/46	0/ 0/46	46/92/92	46/46/92	46/46/92	46/46/92	46/92	92	100

* over rear / en arrière

TAB 130287/130272

Les forces de levage sont données en kips (1,000 lbs). 3

Lifting capacities on telescopic boom. Forces de levage à la flèche télescopique.

LTM 1100/2



38 ft – 171 ft



360°

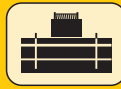

33100 lbs

85%

ft	38 ft		50 ft	62 ft	74 ft	87 ft	99 ft	111 ft	123 ft	135 ft	148 ft	160 ft	171 ft	ft
	* over rear / en arrière													
9.8	201	183												9.8
10	199	182	148	140										10
12	174	165	150	142	135									12
14	152	147	145	141	133	113								14
16	134	130	129	129	122	110	92.5							16
18	120	115	116	115	108	99	89.5	72.5	61.5					18
20	106	102	103	101	95	92	85	72	61.5					20
22	95.5	90.5	92	89.5	86.5	82.5	76.5	69	59.5	49.2				22
24	85	80.5	82	80.5	78.5	74	69	64.5	57.3	48.6				24
26	75.5	72	73.5	74.5	70.5	66.5	62.5	59.1	55	47.2	41.6			26
28	66.5	65	66.5	68	64.5	61	57.5	54.5	50.9	46	40.6	31.9		28
30			61	62	58.9	55.8	52.6	50.9	48.1	44.3	39.4	31.7		30
32			55.1	56.4	54.3	51.5	48.9	47.4	44.4	41.5	38.4	31.1	25.2	32
34			50.4	51.7	50.3	47.8	46.4	44.2	41.2	38.7	36.8	30.5	24.9	34
36			46.2	47.5	46.7	44.4	43.5	41.2	38.4	36.5	34.8	30	24.4	36
38			42	43.3	43.1	41.1	40.6	38.2	35.5	34.6	32.7	29.5	24	38
40				39.6	39.7	38.4	37.9	36.3	33	32.6	30.8	28.8	23.5	40
45				32.7	32.8	32.5	32.4	31	29.6	28.7	27.7	25.9	22.5	45
50				27.5	28.4	27.5	27.9	27.2	26.6	25.5	24.3	22.7	21.2	50
55					24.5	23.3	24.1	24.2	23.5	22.2	21.3	19.7	19.3	55
60					21.1	20.4	21.6	21.4	20.6	19.5	18.6	17.2	16.8	60
65					18.6	18.6	18.9	18.7	18.3	17.3	16.5	15.1	14.8	65
70						16.5	16.7	16.5	16.2	15.4	14.6	13.3	13	70
75						14.7	14.9	14.6	14.3	13.5	12.9	11.7	11.5	75
80							13.3	12.9	12.5	11.8	11.3	10.3	10.1	80
85							12	11.6	11.2	10.5	10	9	8.9	85
90							10.9	10.4	10	9.4	8.9	7.9	7.8	90
95								9.4	9	8.4	7.9	7	6.8	95
100									8.1	7.5	7	6.1	6	100
105									7.3	6.7	6.2	5.3	5.2	105
110									6.6	6	5.5	4.6	4.5	110
115										5.3	4.9	4	3.9	115
120										4.7	4.3	3.4	3.4	120
125											3.7	2.9	2.8	125
130												3.1	2.4	130
135													2.7	135
I	0		0/ 0/ 0	46/ 0/ 0	92/ 0/ 0	0/ 0/ 0	46/ 0/ 0	92/46/ 0	92/46/ 0	92/46/ 0	92/46	92	100	I
II	0		46/ 0/ 0	46/46/ 0	46/ 0/ 0	46/ 0/ 0	46/46/ 0	46/46/ 0	92/92/46	92/92/92	92/92	92	100	II
III	0		0/ 0/ 0	0/46/ 0	0/46/ 0	46/92/ 0	46/46/46	46/46/92	46/92/92	92/92/92	92/92	92	100	III
IV	0		0/46/ 0	0/ 0/46	0/46/46	46/46/92	46/46/92	46/46/92	46/46/92	46/92/92	92/92	92	100	IV
V	0		0/ 0/46	0/ 0/46	0/46/92	46/46/92	46/92/92	46/92/92	46/46/92	46/46/92	46/92	92	100	V

* over rear / en arrière

TAB 130160/130165

Lifting capacities on telescopic boom. Forces de levage à la flèche télescopique.

LTM 1100/2



38 ft – 62 ft



0°

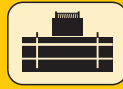

57300 lbs¹⁾ / 33100 lbs²⁾

85%

ft	38 ft		50 ft		62 ft		ft
	1)	2)	1)	2)	1)	2)	
9.8	57.3	57.3					9.8
10	57	57	55.1	55.1	56.2	56.2	10
12	53	53	54.1	54.1	55.2	55.2	12
14	48.9	48.9	50	50	51.1	50.7	14
16	44.9	44.9	46	46	47.1	45.1	16
18	43.2	40.2	44.6	41.4	45.6	40.2	18
20	41.8	35.3	43.5	36.8	44.4	35.7	20
22	38.4	30.7	40.1	32.5	41	32.2	22
24	35.3	26.8	37	28.7	37.9	29.1	24
26	32.4	23.5	34.2	25.4	35.2	26.4	26
28	29.3	21	31.1	22.8	32.1	23.8	28
30			28.1	20.4	29.1	21.5	30
32			25.7	18.5	26.6	19.5	32
34			23.6	16.9	24.6	17.8	34
36			21.8	15.5	22.7	16.4	36
38			20	14	20.9	15	38
40					19.3	13.7	40
45					16.2	11.2	45
50					13.8	9.3	50
I	0		0		0		I
II	0		0		0		II
III	0		0		0		III
IV	0		0		0		IV
V	0		46		92		V

0° = over rear / en arrière

TAB 130252 / 130255

Lifting heights. Hauteurs de levage.

LTM 1100/2

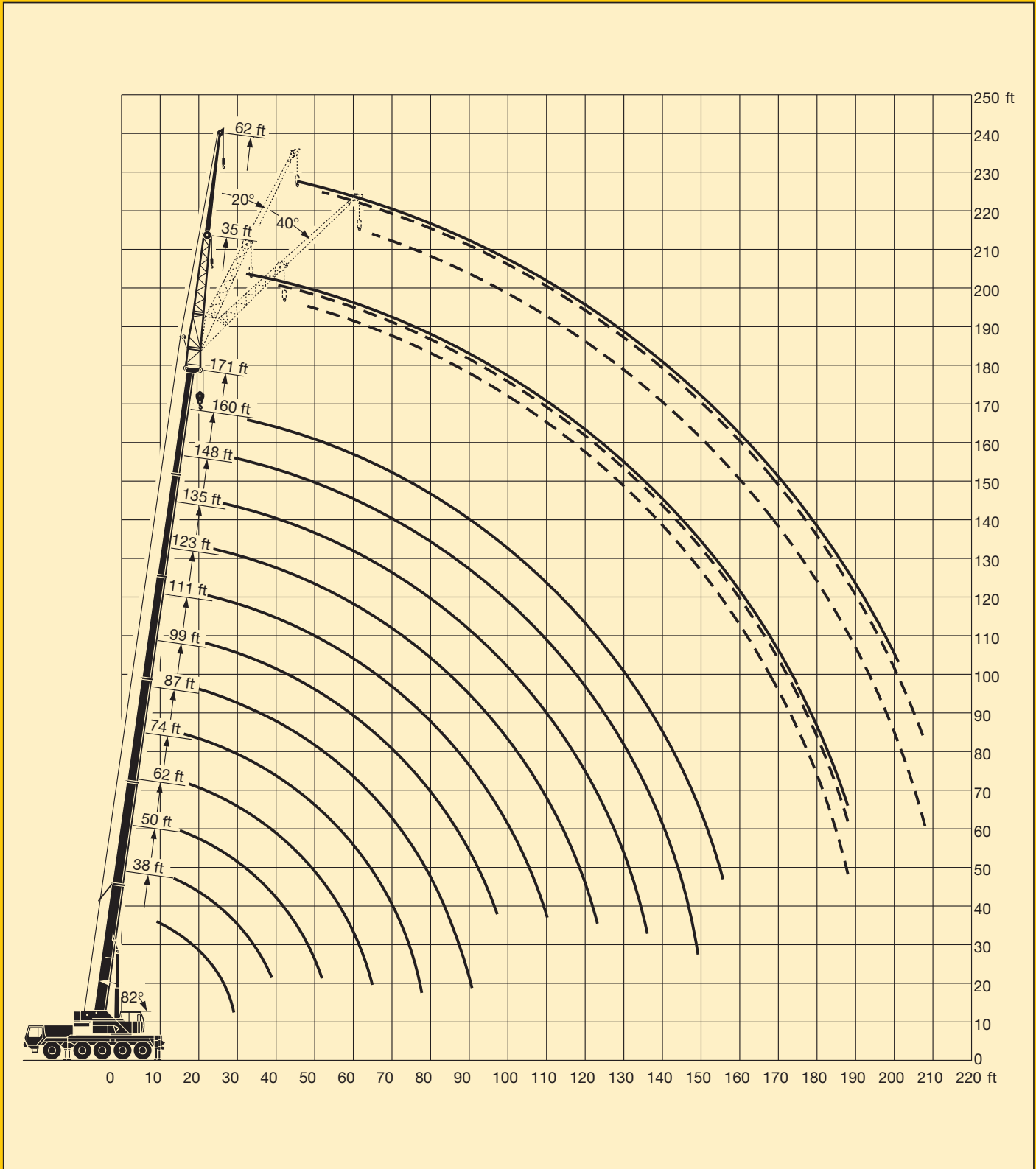

Lifting capacities on the folding jib. Forces de levage à la fléchette pliante.

LTM 1100/2



38 ft – 171 ft

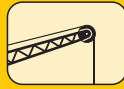

35 ft



360°

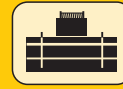

77200 lbs



85%

ft	38 ft			123 ft			135 ft			148 ft			160 ft			171 ft			ft
	0°	20°	40°	0°	20°	40°	0°	20°	40°	0°	20°	40°	0°	20°	40°	0°	20°	40°	
9	41.9																		9
10	41.9																		10
12	41.7																		12
14	40.9																		14
16	40.2																		16
18	38.5																		18
20	36.6	34.4																	20
22	34.8	33.6																	22
24	32.9	32.8																	24
26	31	32		34.1															26
28	29.7	30.7	26.7	33.6			30.6												28
30	28.5	29.3	26.4	33.1			30.5												30
32	27.3	28	25	32.6			30.2		24.3										32
34	26.1	26.8	24	32.1			29.8		24.1										34
36	24.9	25.7	23.1	31.6			29.5		23.7										36
38	23.6	24.7	22.2	31.2	27.3		29.2		23.3			18.7				15.3			38
40	22.6	23.6	21.3	30.8	27.2		28.9		23			18.7				15.2			40
45	20.9	21	19.1	29.8	26.3		28.3	25.2	22.2	20.9		18				14.6			45
50	19.1	19.3	17.6	28.3	25.1	20.8	27.2	24.5	21.2	21.5	20.2	17.4	16.3			14	13.1		50
55	17.4	17.9	16.6	26.6	23.9	20.5	25.9	23.6	20.8	20.7	19.5	16.7	15.9			13.4	12.8		55
60				25	22.8	20	24.4	22.6	20	19.8	18.7	18	16	15.3	14.9	13.4	12.4	12.2	60
65				23.4	21.7	19.3	23	21.7	19.3	19	17.9	17.3	15.4	14.7	14.4	12.3	11.9	11.7	65
70				21.9	20.7	18.6	21.8	20.9	18.7	18.3	17.2	16.7	14.8	14.2	13.9	11.9	11.4	11.3	70
75				20.5	19.8	18	20.6	20	18.1	17.6	16.5	16.1	14.2	13.6	13.4	11.4	11	10.8	75
80				19.1	18.9	17.2	19.3	19.2	17.6	16.9	15.9	15.5	13.7	13.2	13	11	10.6	10.5	80
85				17.7	17.7	16.4	17.8	18.2	17.1	16.2	15.3	14.9	13.2	12.7	12.6	10.6	10.2	10.1	85
90				16.2	16.5	15.8	16	16.8	16.7	15.4	14.8	14.4	12.8	12.3	12.2	10.3	9.9	9.8	90
95				14.7	15.3	14.8	14.4	14.9	15.3	14	14.1	14	12.4	11.9	11.8	9.9	9.5	9.4	95
100				13.2	14.1	13.7	13.3	13.6	13.6	12.4	13.1	13.4	12	11.6	11.5	9.6	9.2	9.1	100
105				11.9	12.7	12.8	12.2	12.8	13.1	11.6	12	12.5	11.5	11.2	11.2	9.2	8.9	8.9	105
110				11.2	11.7	11.9	11.3	11.8	12.1	11.1	11	11.4	10.6	10.9	10.9	8.9	8.7	8.6	110
115				10.4	10.8	11.1	10.4	10.9	11.2	10.5	10.5	10.6	9.7	10.3	10.5	8.6	8.4	8.4	115
120				9.6	10	10.2	9.8	10	10.3	9.8	10.1	10.2	8.9	9.5	9.8	8.3	8.2	8.2	120
125				9.2	9.3	9.4	9.4	9.5	9.7	9	9.5	9.7	8.2	8.7	9	8	7.9	8	125
130				8.8	8.9	9.1	8.9	9.1	9.3	8.4	8.8	9	7.5	8	8.3	7.4	7.7	7.8	130
135				8.5	8.6	8.7	8.4	8.6	8.8	7.8	8.1	8.3	6.9	7.4	7.6	6.8	7.2	7.4	135
140				8.1	8.2	8.4	7.8	8	8.2	7.2	7.5	7.7	6.4	6.8	7	6.2	6.6	6.9	140
145							7.3	7.5	7.6	6.7	6.9	7.1	5.8	6.2	6.4	5.7	6	6.3	145
150							6.8	7	7	6.2	6.4	6.6	5.4	5.7	5.9	5.2	5.5	5.7	150
155							6.4	6.5		5.7	6	6.1	4.9	5.2	5.4	4.7	5.1	5.3	155
160										5.3	5.5	5.6	4.5	4.8	4.9	4.3	4.6	4.8	160
165										4.9			4.1	4.3	4.4	3.9	4.2	4.3	165
170										4.6			3.8	4	4	3.6	3.8	3.9	170
175													3.4	3.6	3.6	3.2	3.4	3.5	175
180													3.1			2.9	3.1	3.2	180
185																2.6	2.8	2.8	185
190																2.3	2.4	2.4	190
I	0			46/ 0			92/46/ 0			92/46			92			100			I
II	0			92/46			92/92/92			92/92			92			100			II
III	0			92/92			92/92/92			92/92			92			100			III
IV	0			46/92			46/92/92			92/92			92			100			IV
V	0			46/92			46/46/92			46/92			92			100			V

TAB 130273/130275/130277

Lifting capacities on the folding jib. Forces de levage à la fléchette pliante.

LTM 1100/2



38 ft - 171 ft

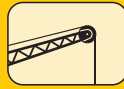

62 ft



360°

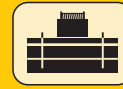

77200 lbs



85%

ft	38 ft			123 ft			135 ft			148 ft			160 ft			171 ft			ft	
	0°	20°	40°	0°	20°	40°	0°	20°	40°	0°	20°	40°	0°	20°	40°	0°	20°	40°		
14	18.5																		14	
16	18.5																		16	
18	18.3																		18	
20	18																		20	
22	17.8																		22	
24	17.5																		24	
26	17.3																		26	
28	16.7																		28	
30	16.1																		30	
32	15.5	11.9		13.3															32	
34	14.9	11.7		13.3															34	
36	14.3	11.3		13.3															36	
38	13.7	11		13.3			12.7			11.9			10.7						38	
40	13.2	10.7		13.3			12.7			11.9			10.7						40	
45	12.3	10		13.2			12.7			11.9			10.7			9			45	
50	11.4	9.4	8	13.1	10.5		12.7			11.9			10.7			9			50	
55	10.6	8.9	7.8	12.9	10.4		12.5			11.8			10.7			8.9			55	
60	9.8	8.5	7.5	12.6	10		12.3	10.2		11.6			10.7			8.7			60	
65	9.1	8.1	7.3	12.3	9.7		12.1	9.9		11.4	9.7		10.5	9.5		8.7			65	
70	8.6	7.8	7.1	11.9	9.4	7.7	11.8	9.6	7.8	11.2	9.5		10.4	9.3		8.6	8.3		70	
75	8.2	7.5	7	11.6	9.2	7.7	11.6	9.3	7.7	11.1	9.3		10.1	9.1		8.4	8.2		75	
80	7.8	7.2	6.9	11.3	8.9	7.6	11.4	9.1	7.6	10.9	9.1	7.7	9.9	9		8.1	7.9		80	
85	7.5	7	6.8	10.9	8.7	7.5	11.2	8.8	7.5	10.8	8.8	7.6	9.6	8.8	7.5	7.9	7.7	7.6	85	
90	7.1			10.6	8.5	7.4	10.8	8.6	7.4	10.6	8.7	7.5	9.4	8.6	7.5	7.6	7.5	7.5	90	
95				10.3	8.3	7.3	10.5	8.4	7.4	10.4	8.5	7.4	9.1	8.5	7.4	7.4	7.2	7.3	95	
100				9.9	8.2	7.3	10.2	8.3	7.3	10.2	8.4	7.3	8.9	8.3	7.4	7.2	7	7	100	
105				9.6	8.1	7.2	9.9	8.1	7.3	9.9	8.2	7.3	8.7	8.2	7.3	7	6.8	6.8	105	
110				9.3	8	7.2	9.6	8	7.2	9.7	8.1	7.3	8.5	8.1	7.3	6.8	6.6	6.6	110	
115				9.1	7.8	7.1	9.4	7.9	7.2	9.5	8	7.3	8.3	8	7.3	6.6	6.4	6.4	115	
120				8.8	7.7	7	9	7.7	7.2	9.1	7.9	7.3	8.1	7.9	7.3	6.4	6.2	6.3	120	
125				8.5	7.6	6.9	8.8	7.6	7.2	8.6	7.8	7.3	7.9	7.7	7.3	6.2	6.1	6.1	125	
130				8.1	7.5	6.8	8.6	7.5	7.2	7.9	7.7	7.3	7.7	7.5	7.3	6	5.9	5.9	130	
135				7.7	7.4	6.7	8.1	7.5	7.2	7.5	7.6	7.3	7.3	7.4	7.3	5.9	5.8	5.8	135	
140				7.3	7.2	6.5	7.6	7.4	7.2	7.3	7.3	7.2	7.2	7.2	7.2	5.7	5.6	5.7	140	
145				6.9	6.9	6.3	7	7.4	7.2	7.1	7	7.2	6.3	7	7.1	5.6	5.5	5.6	145	
150				6.5	6.6	6.1	6.8	7	7.2	6.6	6.9	6.9	5.8	6.5	6.9	5.4	5.4	5.4	150	
155				6.1	6.3	5.9	6.6	6.6	6.8	6.2	6.6	6.8	5.4	6	6.5	5.1	5.2	5.3	155	
160				5.7	6	5.7	6.3	6.5	6.6	5.7	6.2	6.5	5	5.6	6	4.8	5.1	5.2	160	
165				5.3	5.7		5.9	6.3	6.4	5.3	5.8	6	4.6	5.1	5.5	4.4	4.9	5.1	165	
170				4.9	5.4		5.5	5.8	5.9	4.9	5.3	5.6	4.2	4.7	5	4	4.5	4.9	170	
175							5.2	5.4	5.5	4.6	5	5.1	3.8	4.3	4.6	3.6	4.1	4.5	175	
180							4.9	5.1		4.3	4.6	4.7	3.5	3.9	4.1	3.3	3.8	4.1	180	
185										4	4.2	4.3	3.2	3.6	3.7	3	3.4	3.7	185	
190										3.7	3.9	3.9	2.9	3.2	3.4	2.7	3.1	3.3	190	
195										3.4				2.6	2.9	3	2.4	2.8	3	195
200														2.4	2.6	2.6	2.2	2.5	2.6	200
205														2.1			2.2	2.2	2.2	205
I	0			46/ 0			92/46/ 0			92/46			92			100			I	
II	0			92/46			92/92/92			92/92			92			100			II	
III	0			92/92			92/92/92			92/92			92			100			III	
IV	0			46/92			46/92/92			92/92			92			100			IV	
V	0			46/92			46/46/92			46/92			92			100			V	

TAB 130273/130275/130277

Lifting capacities on the folding jib. Forces de levage à la fléchette pliante.

LTM 1100/2



38 ft – 171 ft

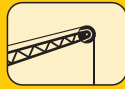

35 ft



360°

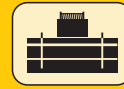

57300 lbs

85%

ft	38 ft			123 ft			135 ft			148 ft			160 ft			171 ft			ft	
	35 ft			35 ft			35 ft			35 ft			35 ft			35 ft				
	0°	20°	40°	0°	20°	40°	0°	20°	40°	0°	20°	40°	0°	20°	40°	0°	20°	40°		
10	41.9																		10	
12	41.7																		12	
14	40.9																		14	
16	40.2																		16	
18	38.5																		18	
20	36.6	34.4																	20	
22	34.8	33.6																	22	
24	32.9	32.8																	24	
26	31	32		34.1															26	
28	29.7	30.7	26.7	33.6			30.6												28	
30	28.5	29.3	26.4	33.1			30.5												30	
32	27.3	28	25	32.6			30.2			24.3									32	
34	26.1	26.8	24	32.1			29.8			24.1									34	
36	24.9	25.7	23.1	31.6			29.5			23.7									36	
38	23.6	24.7	22.2	31.2	27.3		29.2			23.3			18.7				15.3		38	
40	22.6	23.6	21.3	30.8	27.2		28.9			23			18.7				15.2		40	
45	20.9	21	19.1	29.8	26.3		28.3	25.2		22.2	20.9		18				14.6		45	
50	19.1	19.3	17.6	28.3	25.1	20.8	27.2	24.5	21.2	21.5	20.2		17.4	16.3			14	13.1	50	
55	17.4	17.9	16.6	26.6	23.9	20.5	25.9	23.6	20.8	20.7	19.5		16.7	15.9			13.4	12.8	55	
60				25	22.8	20	24.2	22.6	20	19.8	18.7	18	16	15.3	14.9		12.8	12.4	60	
65				23.3	21.7	19.3	21.9	21.7	19.3	19	17.9	17.3	15.4	14.7	14.4		12.3	11.9	65	
70				21.1	20.7	18.6	19.6	20.5	18.7	18.3	17.2	16.7	14.8	14.2	13.9		11.9	11.4	70	
75				19	19.6	18	17.9	18.9	18.1	17.1	16.5	16.1	14.2	13.6	13.4		11.4	11	75	
80				17.1	18.2	17.2	16.9	16.9	17.4	15.5	15.8	15.5	13.7	13.2	13		11	10.6	80	
85				15.4	16.4	16.4	15.3	15.5	16.1	13.8	15.1	14.9	13.2	12.7	12.6		10.6	10.2	85	
90				13.6	14.4	15.3	13.5	14.1	14.5	12.9	13.4	13.8	12.4	12.3	12.2		10.3	9.9	90	
95				12.2	12.8	13.8	12.3	12.9	13.5	12.2	12	12.6	11.5	11.8	11.8		9.9	9.5	95	
100				11.5	11.7	12.2	11.7	11.7	12.2	11.3	11.5	11.5	10.4	11.1	11.3		9.5	9.2	100	
105				10.9	10.7	11.1	10.9	11.1	11.1	10.3	10.9	11.2	9.4	10.1	10.6		9.1	8.9	105	
110				10.4	10.4	10.3	10.1	10.5	10.6	9.5	10	10.4	8.5	9.2	9.7		8.2	8.7	110	
115				9.9	10	10	9.3	9.7	10	8.7	9.2	9.5	7.7	8.4	8.8		7.4	8.1	115	
120				9.3	9.5	9.7	8.5	9	9.2	7.9	8.4	8.7	6.9	7.6	8		6.7	7.3	120	
125				8.6	8.9	9.1	7.9	8.2	8.5	7.2	7.7	8	6.2	6.8	7.2		6	6.6	125	
130				8	8.3	8.4	7.2	7.6	7.8	6.5	7	7.3	5.6	6.2	6.5		5.3	5.9	130	
135				7.4	7.6	7.7	6.6	6.9	7.1	5.9	6.3	6.6	5	5.5	5.8		4.8	5.3	135	
140				6.8	7	7.1	6.1	6.4	6.5	5.4	5.8	6	4.5	4.9	5.2		4.2	4.7	140	
145							5.6	5.8	5.9	4.9	5.2	5.4	4	4.4	4.6		3.7	4.2	145	
150							5	5.3	5.3	4.4	4.7	4.8	3.5	3.9	4.1		3.3	3.7	150	
155							4.6	4.7		3.9	4.2	4.3	3	3.4	3.6		2.8	3.2	155	
160										3.4	3.7	3.7	2.6	2.9	3		2.4	2.8	160	
165										3			2.1	2.4	2.5			2.3	2.5	165
170										2.7			1.7	2	2			1.9	2	170
I	0			46/ 0			92/46/ 0			92/46			92			100			I	
II	0			92/46			92/92/92			92/92			92			100			II	
III	0			92/92			92/92/92			92/92			92			100			III	
IV	0			46/92			46/92/92			92/92			92			100			IV	
V	0			46/92			46/46/92			46/92			92			100			V	

TAB 130274/130276/130278

Lifting capacities on the folding jib. Forces de levage à la fléchette pliante.

LTM 1100/2



38 ft – 171 ft

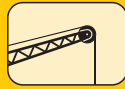

62 ft



360°

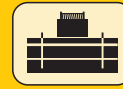

57300 lbs

85%

ft	38 ft			123 ft			135 ft			148 ft			160 ft			171 ft			ft
	62 ft			62 ft			62 ft			62 ft			62 ft			62 ft			
	0°	20°	40°	0°	20°	40°	0°	20°	40°	0°	20°	40°	0°	20°	40°	0°	20°	40°	
14	18.5																		14
16	18.5																		16
18	18.3																		18
20	18																		20
22	17.8																		22
24	17.5																		24
26	17.3																		26
28	16.7																		28
30	16.1																		30
32	15.5	11.9		13.3															32
34	14.9	11.7		13.3															34
36	14.3	11.3		13.3															36
38	13.7	11		13.3			12.7			11.9			10.7						38
40	13.2	10.7		13.3			12.7			11.9			10.7						40
45	12.3	10		13.2			12.7			11.9			10.7			9			45
50	11.4	9.4	8	13.1	10.5		12.7			11.9			10.7			9			50
55	10.6	8.9	7.8	12.9	10.4		12.5			11.8			10.7			8.9			55
60	9.8	8.5	7.5	12.6	10		12.3	10.2		11.6			10.7			8.7			60
65	9.1	8.1	7.3	12.3	9.7		12.1	9.9		11.4	9.7		10.5	9.5		8.7			65
70	8.6	7.8	7.1	11.9	9.4	7.7	11.8	9.6	7.8	11.2	9.5		10.4	9.3		8.6	8.3		70
75	8.2	7.5	7	11.6	9.2	7.7	11.6	9.3	7.7	11.1	9.3		10.1	9.1		8.4	8.2		75
80	7.8	7.2	6.9	11.3	8.9	7.6	11.4	9.1	7.6	10.9	9.1	7.7	9.9	9		8.1	7.9		80
85	7.5	7	6.8	10.9	8.7	7.5	11.2	8.8	7.5	10.8	8.8	7.6	9.6	8.8	7.5	7.9	7.7	7.6	85
90	7.1			10.6	8.5	7.4	10.8	8.6	7.4	10.6	8.7	7.5	9.4	8.6	7.5	7.6	7.5	7.5	90
95				10.3	8.3	7.3	10.5	8.4	7.4	10.4	8.5	7.4	9.1	8.5	7.4	7.4	7.2	7.3	95
100				9.9	8.2	7.3	10.2	8.3	7.3	10.2	8.4	7.3	8.9	8.3	7.4	7.2	7	7	100
105				9.6	8.1	7.2	9.9	8.1	7.3	9.9	8.2	7.3	8.7	8.2	7.3	7	6.8	6.8	105
110				9.3	8	7.2	9.5	8	7.2	9	8.1	7.3	8.5	8.1	7.3	6.8	6.6	6.6	110
115				8.9	7.8	7.1	9	7.9	7.2	8.3	8	7.3	8.1	8	7.3	6.6	6.4	6.4	115
120				8.4	7.7	7	8.3	7.7	7.2	8.1	7.9	7.3	7.5	7.9	7.3	6.4	6.2	6.3	120
125				7.7	7.6	6.9	7.8	7.6	7.2	7.8	7.7	7.3	6.8	7.7	7.3	6.2	6.1	6.1	125
130				7.4	7.5	6.8	7.6	7.5	7.2	7.1	7.5	7.3	6.2	7.2	7.3	5.9	5.9	5.9	130
135				7.2	7.1	6.7	7.1	7.2	7.2	6.5	7.2	7.3	5.6	6.6	7.1	5.3	5.8	5.8	135
140				7	6.9	6.5	6.6	7	7.2	6	6.7	7.1	5.1	6	6.7	4.8	5.5	5.7	140
145				6.8	6.7	6.3	6.1	6.7	7	5.5	6.2	6.7	4.6	5.4	6	4.3	5.2	5.5	145
150				6.3	6.6	6.1	5.6	6.2	6.5	5	5.6	6.1	4.1	4.9	5.4	3.8	4.7	5.3	150
155				5.9	6.2	5.9	5.2	5.7	6	4.5	5.1	5.5	3.6	4.4	4.9	3.4	4.2	4.8	155
160				5.5	5.8	5.7	4.7	5.2	5.4	4.1	4.7	5	3.2	3.9	4.4	3	3.7	4.2	160
165				5	5.3		4.3	4.7	4.9	3.7	4.2	4.5	2.8	3.5	3.9	2.6	3.3	3.8	165
170				4.6	4.9		3.9	4.3	4.5	3.3	3.8	4.1	2.5	3.1	3.4	2.2	2.9	3.3	170
175							3.5	3.9	3.9	2.9	3.4	3.6	2.1	2.7	3	1.9	2.5	2.9	175
180							3.2	3.4		2.5	3	3.1		2.3	2.5		2.1	2.4	180
185										2.2	2.6	2.6							185
190										1.9	2.2	2.1							190
I	0			46/ 0			92/46/ 0			92/46			92			100			I
II	0			92/46			92/92/92			92/92			92			100			II
III	0			92/92			92/92/92			92/92			92			100			III
IV	0			46/92			46/92/92			92/92			92			100			IV
V	0			46/92			46/46/92			46/92			92			100			V

TAB 130274/130276/130278

Dimensions. Encombrement.

LTM 1100/2

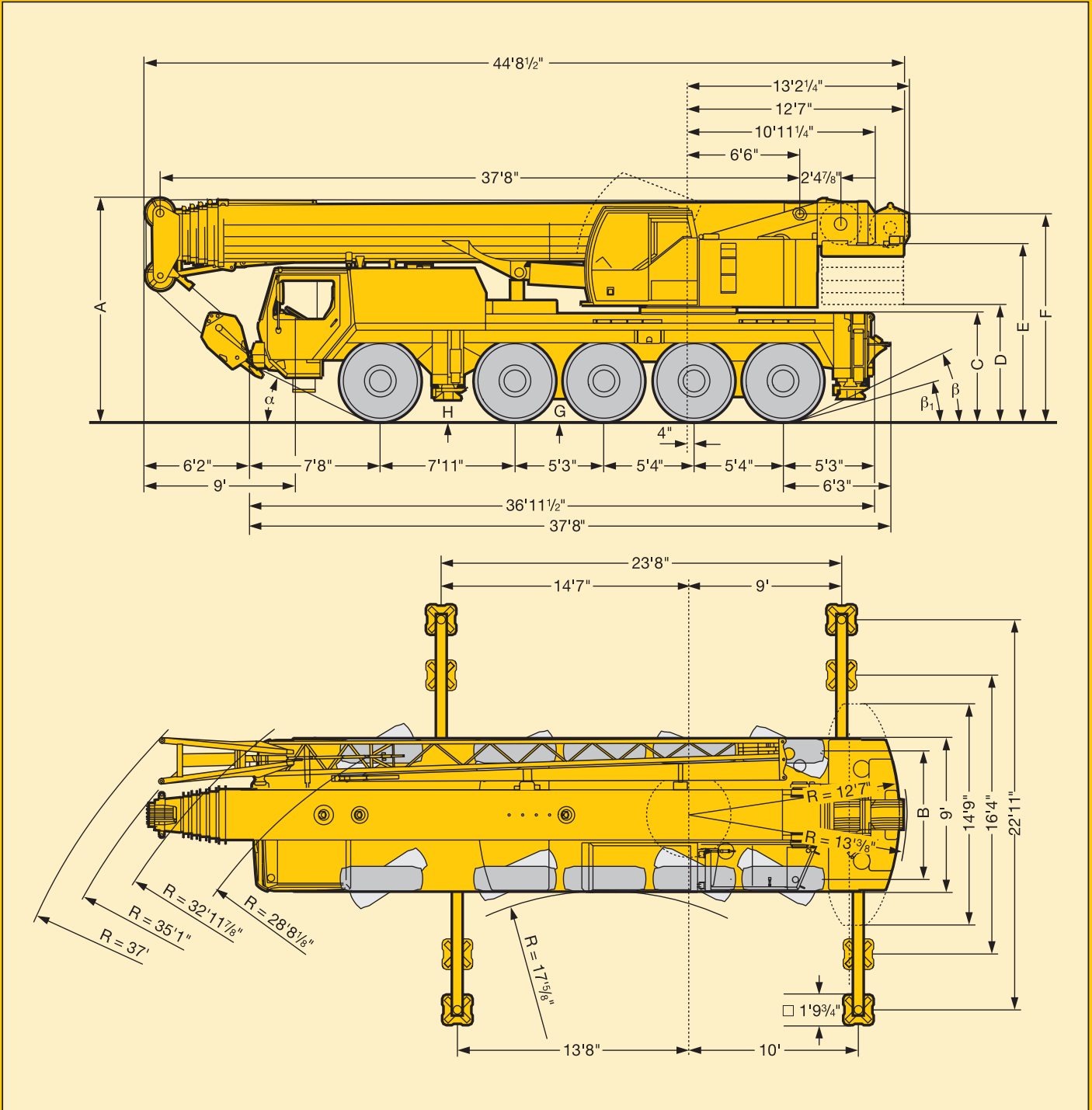

	Dimensions / Encombrement												
	A	A*	B	C	D	E	F	G	H	α	β	β_1	
16.00 R 25	13'1"	12'9"	7'6"	6'4"	6'8 ⁵ / ₈ "	10'3 ³ / ₄ "	12'1"	17"	13 ³ / ₂ "	25°	25°	18°	

* lowered / abaissé



Axle Essieu	1	2	3	4	5	Total weight Poids total
lbs	26400	26400	26400	26400	26400	132000 ¹⁾

¹⁾ with 25350 lbs counterweight / avec contrepoids 25350 lbs







Load (kips) Forces de levage (kips)	No. of sheaves Poulies	No. of lines Brins	Weight lbs Poids lbs
220	7	14	2730
200	5	11	1540
130	3	7	1540
57	1	3	990
19.4	-	1	550

Working speeds. Vitesses.



	1	2	3	4	5	6	7	8	9	10	11	12	13	14	15	16	R ₁	R ₂	 %
 16.00 R 25  (mp/h)	3	3.5	4.4	5.3	6.4	7.7	9.2	11	13.5	16.4	20	24.2	29.4	35.5	42	50	3.4	3.9	60 %



Drive Mécanismes	infinitely variable en continu	Rope diameter / Rope length Diamètre du câble / Longueur du câble	Max. single line pull Effort au brin maxi.
	0 - 426 ft/min single line ft/min au brin simple	7/8" / 656'	19400 lbs
	0 - 426 ft/min single line ft/min au brin simple	7/8" / 656'	19400 lbs
	0 - 2 rpm		
	approx. 40 seconds to reach 82° boom angle env. 40 s jusqu'à 82°		
	approx. 360 seconds for boom extension from 38 ft - 171 ft env. 360 s pour passer de 38 ft - 171 ft		

Frame:	Self-manufactured, weight-optimized and torsion resistant box-type design of high-tensile structural steel.
Outriggers:	4-point supporting system, hydraulically telescopic into horizontal and vertical direction. Automatic levelling of crane. Electronic inclination indicator.
Engine:	8-cylinder Diesel, make Liebherr, type D 9408 TI-E, watercooled, output 400 kW (544 h.p.) at 1600 – 2000 rpm acc. to ECE-R 24.03 and ECE-R 49.02 (Euro III), max. torque 1790 lbs/ft at 1000 – 1300 rpm. Fuel reservoir: 132 gallons.
Transmission:	ZF 16-speed gear box with automatic control system AS-TRONIC. ZF-intarder fitted directly to the gear. Single-stage transfer case with lockable transfer differential.
Axles:	Hydropneumatic suspension of all 5 axles. Axles 1, 2, 4 and 5 steerable. Axles 1, 4 and 5 are planetary axles with differential locks.
Suspension:	All axles are mounted on hydropneumatic suspension and are lockable hydraulically.
Tyres:	10 tyres, size: 16.00 R 25.
Steering:	Dual circuit power steering. Mechanical/hydrostatic control from the driver's cabin. Backing steering pump. Steering acc. to EG directive 70/311/EEC.
Brakes:	Service brake: Dual circuit, all-wheel servo-air brake. Parking brake: Spring brake actuator, acting on the wheels of the 2 nd and 5 th axle. Sustained-action brakes: Engine brake as exhaust retarder with Liebherr additional brake system ZBS. Intarder on gear. Brakes acc. to EG directives 71/320 EEC.
Driver's cab:	Spacious all-steel cab on resilient suspension with hydraulic shock absorbers, sound and heat absorbing internal panelling acc. to EG directive, safety glazing, operating and control instruments, comfortably equipped.
Electrical system:	Control of the electrical and electronic components by modern data bus technique. 24 Volt DC, 2 batteries 170 Ah each, lighting according to traffic regulations.

Crane superstructure.

Frame:	Self-manufactured, weight-optimized and torsion resistant welded design of high-tensile structural steel; linked by a triple-row roller slewing ring to the carrier for continuous rotation.
Crane engine:	4-cylinder Diesel, make Liebherr, type D 924 TI-E, watercooled, output 149 kW (202 h.p.) at 1800 rpm acc. to EPA/CARB and stage 2 acc. to directive 97/68 EEC, max. torque 641 lbs/ft at 1150 rpm, fuel reservoir: 74 gallons.
Crane drive:	Diesel-hydraulic, with 2 axial piston variable displacement pumps, with servo-control and capacity control, 1 double gear pump, open controlled oil circuits. Compact hydraulic drive flanged to the Diesel engine. Drive assembly completely enclosed for noise abatement.
Control:	Electric "Load Sensing" control, simultaneous operation of 4 working motions, 2 self-centering hand control levers (joy-stick type).
Hoist gear:	Axial piston fixed displacement motor, Liebherr hoist drum with integrated planetary gear and spring-loaded static brake.
Luffing gear:	1 differential ram with pilot-controlled brake valve.
Slewing gear:	Axial piston fixed displacement motor, planetary gear, spring-loaded static brake.
Crane cab:	All-steel construction, entirely galvanized, powder coated, with safety glazing, operating and control instruments, comfortably equipped.
Safety devices:	LICCON safe load indicator, hoist limit switch, safety valves to prevent pipe and hose ruptures.
Teleskopik boom:	Buckling and torsion resistant design of high-tensile structural steel, oviform boom profile, 1 base section and 5 telescopic sections. All telescopic sections hydraulically extendable independent of one another. Rapid-cycle telescoping system "Telematik". Boom length: 38 ft – 171 ft.
Counterweight:	33100 lbs basic counterweight.
Electrical system:	Control of the electrical and electronic components by modern data bus technique. 24 Volt DC, 2 batteries.

Optional equipment.

Swing-away jib:	35 ft – 62 ft long, mountable to the telescopic boom at 0°, 20° or 40°.
2nd Hoist gear:	For two-hook operation or for operation with swing-away jib if the hoist rope shall remain reeved.
Additional counterweight:	44100 lbs for a total counterweight of 77200 lbs.
Drive 10 x 8:	Additional drive of the 2 nd axle.

Further items available on request.

Cadre:	Construction en caisse résistante à la torsion et optimisée en poids réalisée par Liebherr en acier de construction à grain fin très rigide.
Calage:	Dispositif de calage horizontal et vertical en 4 points, entièrement déployable hydrauliquement. Nivellement automatique du calage. Indicateurs électroniques d'inclinaison.
Moteur:	Moteur Diesel, 8 cylindres, fabriqué par Liebherr, type D 9408 TI-E, refroidi à l'eau, puissance 400 kW (544 ch) à 1600 – 2000 rpm suivant ECE-R 24.03. et ECE-R 49.02 (EURO III), couple maxi 1790 lbs/ft à 1000 – 1300 rpm. Réservoir de carburant: 132 gallons.
Boîte de vitesse:	Boîte de vitesses ZF à 16 rapports, mécanisme automatisé à commande AS-TRONIC. Ralentisseur hydrodynamique ZF directement accouplé à la boîte. Boîte de transfert à un étage avec blocage de différentiel.
Essieux:	Les 5 essieux sont à suspension hydropneumatique. Essieux 1, 2, 4 et 5 directeurs. Essieux 1,4 et 5 planétaires avec blocage différentiel.
Suspension:	Suspension hydropneumatique sur tous les essieux. Chaque essieu peut être bloqué hydrauliquement.
Pneumatiques:	10 pneus de taille: 16.00 R 25.
Direction:	Direction hydraulique à 2 circuits. Commande mécanique/hydrostatique depuis la cabine du conducteur. Pompe auxiliaire de direction. Direction conforme aux directives européennes 70/311/CE.
Freins:	Freins de service: servofrein à air comprimé, à 2 circuits. Frein à main: ressort accumulé agissant sur les roues des essieux 2 à 5. Freins continus: frein moteur par clapet sur échappement avec système de ralentissement Liebherr ZBS. Ralentisseur hydrodynamique accouplé à la boîte de vitesses. Freins conformes aux directives européennes 71/320 CE.
Cabine du conducteur:	Cabine spacieuse en tôle d'acier, avec suspension élastique et amortisseurs hydrauliques, revêtement intérieur avec isolation phonique et thermique selon les directives européennes, glaces de sécurité, appareils de commande et de contrôle, équipement confortable.
Installation électrique:	Composants électriques et électroniques reliés entre eux par bus de données moderne. Courant continu 24 Volts, 2 batteries, pour 170 A/h, éclairage conforme au code de la route.

Partie tournante.

Cadre:	Construction soudée résistante à la torsion et optimisée en poids réalisée par Liebherr en acier de construction à grain fin très rigide. Couronne d'orientation à rouleaux à 3 rangées permettant une rotation illimitée sert de pièce de liaison avec le châssis de la grue.
Moteur:	Moteur Diesel, 4 cylindres, fabriqué par Liebherr, type D 924 TI-E, refroidi à l'eau, puissance 149 kW (202 PS) à 1800 rpm selon EPA/CARB et étage 2 selon les directives 97/68 CE, couple maxi 641 lbs/ft à 1150 rpm, réservoir de carburant: 74 gallons.
Entraînement de la grue:	Diesel hydraulique avec 2 pompes à débit variable à pistons axiaux, servocommande et régulation de la puissance, 1 double pompe à engrenages, circuits hydrauliques ouverts et régulés. Entraînement hydraulique compact, accouplé directement au moteur Diesel, mécanisme d'entraînement total fermé pour une bonne insonorisation.
Direction:	Direction électrique "Load Sensing", 4 mouvements de travail dirigeable simultanément, deux leviers de commande à 4 positions et à autocentrage.
Mécanisme de levage:	Moteur à cylindrée constante et à pistons axiaux. Tambour du mécanisme de levage équipé d'un engrenage planétaire et d'un frein d'arrêt commandé par ressort.
Mécanisme de relevage:	1 vérin différentiel avec clapet de frein commandé.
Dispositif de rotation:	Moteur à cylindrée constante à pistons axiaux, engrenage planétaire, frein d'arrêt commandé par ressort.
Cabine du grutier:	Construction en tôle d'acier entièrement zinguée avec peinture par poudrage et cuisson au four, avec glaces de sécurité, appareils de commande et de contrôle, équipement confortable.
Flèche télescopique:	Flèche télescopique en acier à haute résistance à grains fins, à profil ovale, 1 élément de base et 5 éléments télescopiques. Tous les éléments télescopables indépendamment les uns des autres. Système de télescopage séquentiel rapide "Telematik". Longueur de flèche: 39 ft - 171 ft.
Dispositif de sécurité:	Contrôleur de charge "LICCON", limitation de la course pour le levage, soupape de sûreté contre la rupture de tubes et de tuyaux.
Contrepoids:	Contrepoids principal de 33100 lbs.
Installation électrique:	Composants électriques et électroniques reliés entre eux par bus de données moderne. Courant continu 24 Volts, 2 batteries.

Équipement supplémentaire.

Fléchette pliante:	Longueur: 35 ft – 62 ft, montable sous un angle de 0°, 20° ou 40°.
2ème mécanisme de levage:	Pour l'utilisation du deuxième crochet, ou bien pour une utilisation avec fléchette pliante lorsque le câble de levage principal rest mouflé.
Contrepoids supplémentaire:	44100 lbs pour un contrepoids total de 77200 lbs.
Entraînement 10 x 8:	Essieu 2 est entraîné additionnellement.

Autres équipements supplémentaires sur demande.

Please contact

Veillez prendre contact avec

LIEBHERR-WERK EHINGEN GMBH

D-89582 Ehingen/Donau, Telefon (0 73 91) 5 02-0, Telefax (0 73 91) 5 02-33 99

www.lwe.liebherr.de, E-mail: info@lwe.liebherr.com